

Easy Stairs

NEXT LEVEL SAFETY







De EasyStairs randbeveiliging

De EasyStairs randbeveiliging is licht maar toch uiterst stevig. Iedere las punt is belastbaar tot 500 kg. Het stalen rasterhek vervangt de klassieke 3-delige randbeveiliging, door het traliewerk en kantplank in één. Met zijn lichtgewicht, van minder dan 20 kg, is deze veelzijdige toepassing snel te monteren. Dit systeem heeft een excellente product kwaliteit volgens de modernste productmethodes. Een groter assortiment van bevestigingen is leverbaar.







Stalen Rasterhek 1300 x 1180



-  2011311
-  11kg
-  Poedercoat
-  1300x1180mm

Stalen Rasterhek 2600 x 1180



-  2012611
-  18,8kg
-  Poedercoat
-  2600x1180mm

EasyStairs Veiligheidsstaanders 1500 Basis / EasyStairs Veiligheidsstaanders 1500

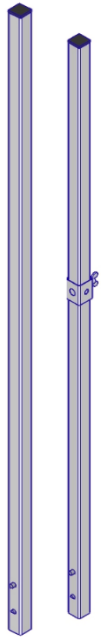

Deze Veiligheidsstaander is ontwikkeld voor gebruik in combinatie met het stalen rasterhek. De in hoogte verstelbare EasyStairs Slider maakt het mogelijk het hek op de juiste hoogte te plaatsen. De EasyStairs Slider (art. 5100000008) wordt altijd geleverd samen met de Veiligheidsstaander 1500 (art. 5031500).

 5031500B/5031500

 2,9kg/3,12kg

 Verzinkt

 1500x35x35mm/1500x35x35mm

EasyStairs Veiligheidsstaander 1300

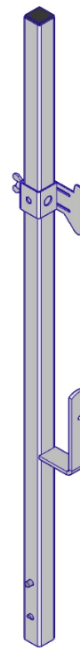

De EasyStairs Veiligheidsstaander 1300 heeft een uitwendig haak voor de montage. Deze Veiligheidsstaander wordt geleverd met de (in gewenste hoogte) EasyStairs Slider (art. 50315008).

 5031300

 3,25kg

 Verzinkt

 1300x35x35mm





EasyStairs Veiligheidsstaander 1195



Deze Veiligheidsstaander is ontwikkeld voor de bevestiging van het rasterhek of met 3-delige houten planken. Bovendien verkrijgbaar met de EasyStairs Plankhouder (art. 50311951).

 5031195

 3,2kg

 Verzinkt

 1195x35x35mm

EasyStairs Veiligheidsstaander 1200

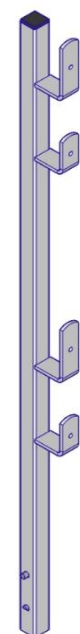

De EasyStairs Veiligheidsstaander 1200 maakt de montage van het stalen rasterhek of de 3-delige houten randbeveiliging, voor verschillende diktes mogelijk.

 5039003

 3,4kg

 Verzinkt

 1200x35x35mm

EasyStairs Veiligheidsstaander Basis

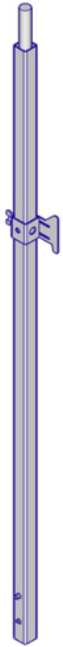

De EasyStairs Veiligheidsstaander Basis kan aan beide zijde worden gebruikt. Enerzijds in een ronde betonhuls en anderzijds in alle overige vierkante houders.

 5030016B

 3,6kg

 Verzinkt

 1500x35x35mm

EasyStairs Veiligheidsstaander Verlengstuk 240 / 425

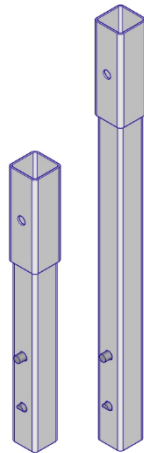

Dit verlengstuk wordt ingezet om de hoogte van de Veiligheidsstaander te vergroten.

 5030240/
5030425

 0,82kg/1,13kg

 Verzinkt

 350x40x40mm/
535x40x40mm

EasyStairs Verstelbare Plankhouder



Met de EasyStairs Verstelbare Plankhouder worden de verschillende diktes van het stalen rasterhek of de 3-delige houten randbeveiliging versterkt. Dit in combinatie met de Veiligheidsstaander Basis (art. 5030016B)

 50315004

 2,4kg

 Verzinkt

 721x109mm

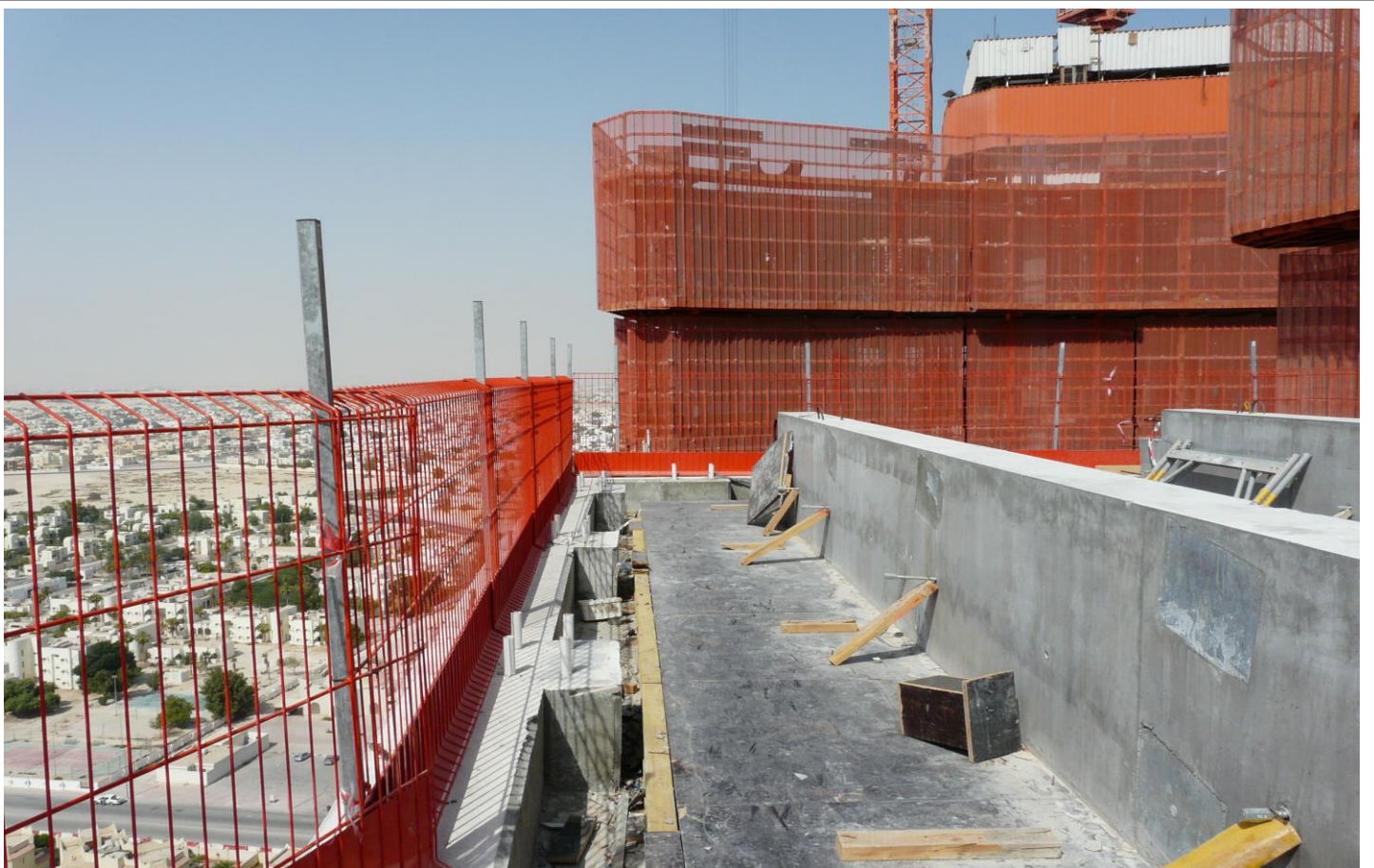

EasyStairs Slider

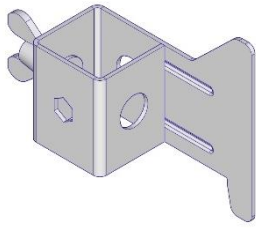

Deze traploze in hoogte verstelbare Slider is toepasbaar bij Veiligheidsstaanders 5031500B, 5031300, 5030016B en 5031500E.

 5100000008

 0,2kg

 Verzinkt

 133x43x105mm

EasyStairs Plankhouder



De EasyStairs Plankhouder (t.b.v. kantplank) dient als houder voor houten planken. In deze Plankhouder is een houten plank (30 mm / 150 mm) te monteren, wat voldoet aan de randbeveiliging norm.

 50311951

 0,46kg

 Verzinkt

 150x102x40mm





EasyStairs Voet



De EasyStairs Voet is geschikt i.c.m. het rasterhek op vlakke ondergronden. De Voet kan bevestigd worden op beton en baksteen met behulp van verschillende schroeven en dubbel bevestigde ankers.

 5040001

 1,42kg

 Verzinkt

 200x153mm

EasyStairs ECO Voet



De EasyStairs ECO Voet is geschikt voor vlakke ondergronden en een kosten- en tijd besparend product. De ECO Voet kan bevestigd worden op beton, baksteen, hout en staal met behulp van verschillende schroeven en dubbel bevestigde ankers.

 5041001

 1,1kg

 Verzinkt

 200x120x35mm

EasyStairs Dak Bevestiging



De EasyStairs Dak Bevestiging is speciaal ontworpen voor schuin aflopende daken. In combinatie met de EasyStairs Veiligheidsstaander weerstaat het alle soorten van dynamische effecten.

 1100000009

 3,03kg

 Verzinkt

 350x50x220mm

EasyStairs Damwand Muurbevestiging



De EasyStairs Damwand Muurbevestiging wordt gebruikt voor het klemmen bij damwanden met een dikte van 5 - 15 mm.

 1100000002

 0,98kg

 Verzinkt

 175x145x46mm

EasyStairs Rand 100

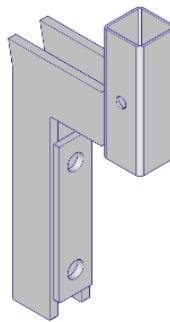

De EasyStairs Rand 100 maakt veilige bevestiging aan de trappenbomen en andere verticale panelen mogelijk.

 5040005

 1,9kg

 Verzinkt

 300x40x40mm

EasyStairs Rand 55



De EasyStairs Rand 55 maakt veilige bevestiging aan de trappenbomen en andere verticale panelen mogelijk.

 50400052

 1,7kg

 Verzinkt

 240x95mm

EasyStairs Adapter



Deze adapter verbindt onze randbeveiliging met andere producenten zoals bijvoorbeeld Meva.

5040032

0,78kg

Verzinkt

230mm

EasyStairs Adapter 25



De EasyStairs Adapter 25 verankert de Veiligheidsstaander in een betonhuls van rond 25mm.

5040016

0,83kg

Verzinkt

230mm

EasyStairs Adapter 40



De EasyStairs Adapter 40 verankert de Veiligheidsstaander in een betonhuls van rond 40mm.

5040017

0,7kg

Verzinkt

230mm

EasyStairs Balkon Aansluiting



Deze houder kan direct aan het metselwerk of balkons bevestigd worden.

5040023

1,32kg

Verzinkt

200x120mm



EasyStairs Spant Klem

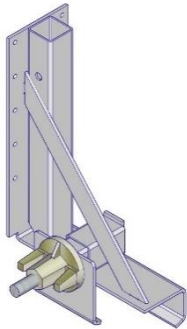

Dit product is ontwikkeld om 40 mm balken (op aanvraag ook 60 mm) met onze Veiligheidsstaander en rasterhek te verbinden. Voor gebruik is geen gereedschap nodig.

 5041003

 4,15kg

 Verzinkt

 304x220x42mm

EasyStairs Grondplaat

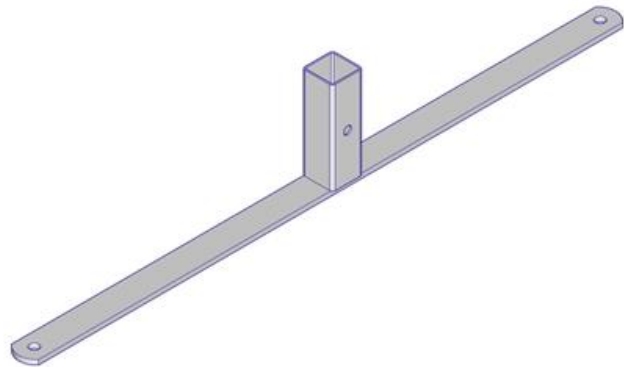

De EasyStairs Grondplaat maakt het mogelijk om gevarenczones af te sluiten zoals bijvoorbeeld opgravingen, laadruimtes, toegangen, etc. Dankzij de geschikte boorgaten kan deze ook eenvoudig vastgezet worden.

 5040013

 1,6kg

 Verzinkt

 795x35x120mm

EasyStairs Instorthuls



De EasyStairs Instorthuls kan direct in beton worden gestort.

 5040011

 0,05kg

 Kunststof plastic

 140x37x37mm



EasyStairs Klem 50



Met de EasyStairs Klem 50 is het mogelijk om zowel horizontaal als verticaal te klemmen. Dit voor vloeren met een dikte van maximaal 500mm.

 1100000006

 6,23kg

 Verzinkt

 840x275mm

EasyStairs Klem XL 60



De EasyStairs Klem XL 60 is veelzijdig en extreem robuust. Te klemmen vanaf 5mm tot 600mm. De vast gelaste DW15 maakt een snelle fixatie met de hamer mogelijk.

 50400028

 5,5kg

 Verzinkt

 840x240mm







EasyStairs Afstandshouder



De EasyStairs Afstandshouder maakt het verschuiven van de staander mogelijk.

 5040009

 3,9kg

 Verzinkt

 200x140x270mm

EasyStairs Schacht Bevestiging

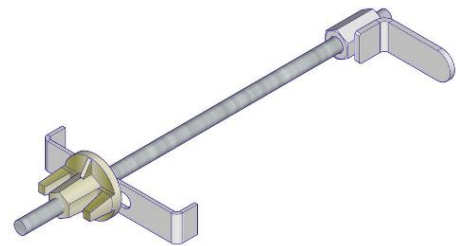

Door middel van de EasyStairs Schacht Bevestiging wordt een veilige bevestiging van barrières aan de muur mogelijk zoals bijvoorbeeld liftschachten. Dit zonder te boren.

 5040015

 2,0kg

 Verzinkt

 400x175mm

EasyStairs Randbevestiging

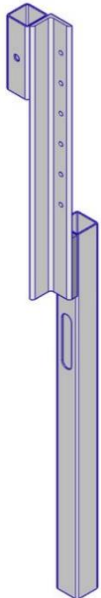

Dit product wordt verticaal gemonteerd en dient om een zijbeschermingspaal vast te houden. De Randbevestiging biedt de mogelijkheid om een houten plank te plaatsen.

 5040027

 2,8kg

 Verzinkt

 600x40x40mm

EasyStairs Frontfix

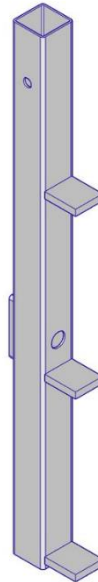

De Frontfix wordt verticaal gemonteerd en dient om een houten plank te bevestigen. Het enkele bevestigingspunt biedt veelzijdige toepassingsmogelijkheden.

 5040018

 1,8kg

 Verzinkt

 600x40x400mm

EasyStairs Rasterhek Box 25



In deze stalen box kunnen 25 EasyStairs Stalen Rasterhek rechtopstaand worden geplaatst en veilig worden getransporteerd. Twee boxen kunnen op elkaar worden gestapeld.

 2010001

 60kg

 Verzinkt

 1160x790x1300mm

EasyStairs Rasterhek Box 60



In deze stalen box kunnen 60 EasyStairs Stalen Rasterhek diagonaal worden geplaatst en veilig worden getransporteerd.

 2010007

 88kg

 Verzinkt

 1210x1210x1300mm

EasyStairs Box met Kraanhaken



De EasyStairs Box met Kraanhaken is speciaal ontwikkeld voor transport met een kraan en heftruck. Ook is deze box stapelbaar.

 6010006

 68kg

 Gelakt/Geschilderd

 1360x840x970mm

EasyStairs Euro Box

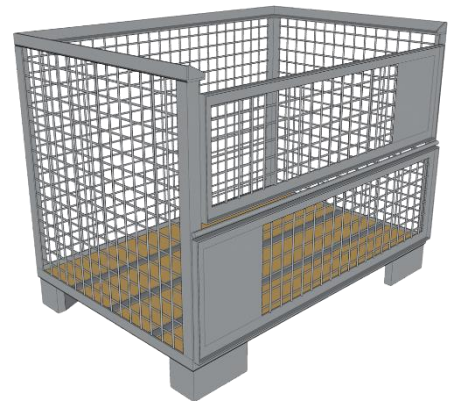

De EasyStairs Euro Box is een veilig transport middel voor materialen.

 6010003

 70kg

 Gelakt/Geschilderd

 1240x840x970mm



